

Installation Instructions

Dynarail® Safety Ladder System



High Performance Composite Solutions



- Corrosion
- Fire
- UV Resistant
- Time
- HIGH**
Strength : Weight
- Low Install Cost
- No tools
- No lightning bolt

Simplified Ladder Instructions



The **Dynarail® Safety Ladder System** has been designed to combine the best in fiberglass reinforced plastic (FRP) ladders and cages with simplicity of installation. Fibergrate has made every attempt to provide clear and thorough instructions for installing these products. If you have any further questions, or need additional information, do not hesitate to contact Fibergrate at (800) 527-4043.

By following these simple instructions, you should find installation of your ladder system quick and easy.

TOOLS REQUIRED

- Drill**
- Bits**
 - 1/8" (for rivets)
 - 9/16" & 11/16" (for connection bolts)
- 25' Tape Measure**
- Sealing Kit**
- Bonding (Epoxy) Kit(s)**
- Wrenches**
 - 7/16" (2 each)
 - 9/16" (2 each)
- Sandpaper (80 grit)**
- Hack Saw**
- Level**
- Stir Sticks**
- "C" Clamps**

NOTE: Cuts and drilled holes must be sealed to maintain corrosion protection.

QUICK TIPS FOR INSTALLING LADDERS



1. Layout ladder, walk thru, wall mount kits and floor mount kits. Cut ladder as required (see **Section I - Installing Ladder and Walk thru**). Attach walk thru to ladder (see **Section I - Installing Ladder and Walk thru**). Attach wall mounts to ladder and mount on wall (see **Section I - Installing Ladder and Walk thru - To Install Wall Mounts**). Attach floor mount clip to ladder and bolt to floor (see **Section I - Installing Ladder and Walk thru - Installing Floor Mounts**).
2. If installing cage, after installation of the ladder, follow the instructions shown in **Section II - Installing Cage** for installation of hoop brackets, hoops and vertical bars.

IMPORTANT

It is the installer's responsibility to carefully follow fabrication and installation plans and instructions to ensure design performance characteristics of the Dynarail® ladder system.

The installer could be liable for claims that result from improper installation.

**DRAWING A -
INSTALLED LADDER**

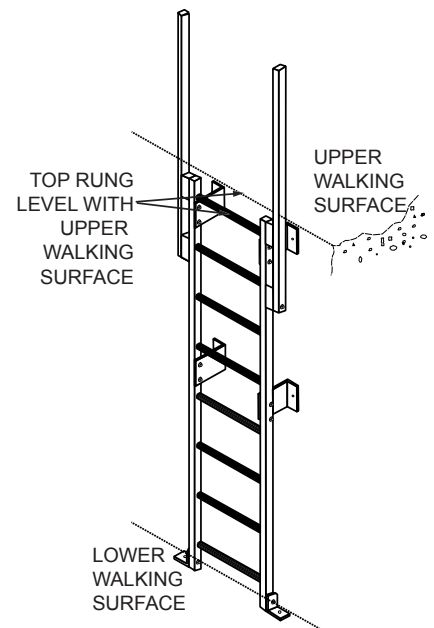

Section I - Installing Ladder

DRAWING B - VARIABLE & FIXED DIMENSIONS

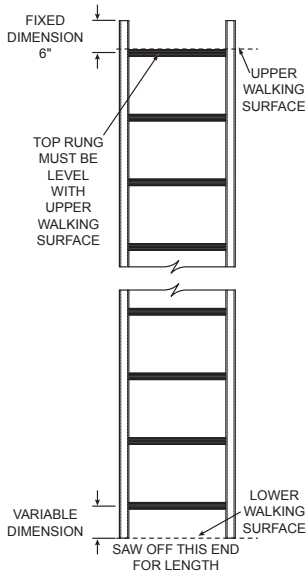

DRAWING C - LADDER RAIL SPLICE

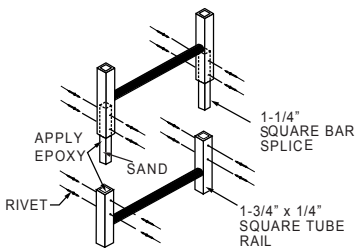

DRAWING D - 18" WIDE WALK THRU WITH SPLICES

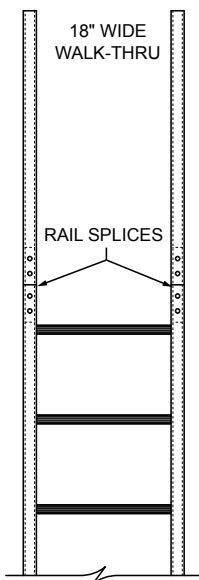

INSTALLING LADDER AND WALK THRU

1. Determine required ladder height by measuring from walking surface at bottom of ladder to step-off at top of ladder. Add 6" to obtain the required overall ladder length. Any adjustment in the ladder length should be made at the ladder bottom (walking surface end - see **Drawing B**). For example, if the overall ladder length determined is 8'-5" and you are working with a 10' ladder, be sure 6 inches are left from the step-off rung to the top and cut 1'-7" from the opposite end (see **Drawing B**).
2. If installing the standard 18" wide walk thru, mix and apply epoxy to splice end (see **Drawing C**) of one of the walk thru posts and insert splice end into the ladder side rail at the top end (see **Drawing D**). Drill for, and install, 4 rivets - 2 on each side of rail. Repeat with other post.

If installing the 24" wide walk thru, place top spacer of one walk thru post as shown in **Drawing E**, drill and bolt loosely into place. Place the bottom spacer in place, match drill and bit into place. Tighten all bolts. Repeat with other walk thru post.

INSTALLING WALL MOUNT BRACKETS

Note: Maximum 6' spacing between brackets and maximum 6' from bottom end of ladder to first bracket. Ladder must be attached to wall or structure at the top rung.

3. With pencil, mark location on wall and ladder where brackets are to be mounted.
4. Locate end of the first wall mount flush with front edge of ladder (**Drawing F**). Match drill two 7/16" diameter holes in ladder rail and bolt bracket to ladder with 3/8" x 3" hex head bolt assemblies. Continue with all wall mount brackets.
5. Drill wall for anchor bolts.
6. Mount ladder to wall with top rung flush with step-off.

INSTALLING FLOOR MOUNT CLIPS

*Note: If floor mount cannot be used, substitute bottom wall mount (**Drawing G**) and install at bottom of ladder using steps 3-6.*

7. Place the floor clip flush with bottom of ladder rail, mark holes in bottom of ladder rail and drill a 7/16" diameter hole (**Drawing H**). Repeat for opposite rail. Bolt floor clips to ladder with 3/8" x 3" hex head bolt assemblies.
8. Drill floor for anchor bolts.
9. Bolt ladder to floor (**Drawing H**).

DRAWING E - 24" WIDE WALK THRU WITH SPACERS

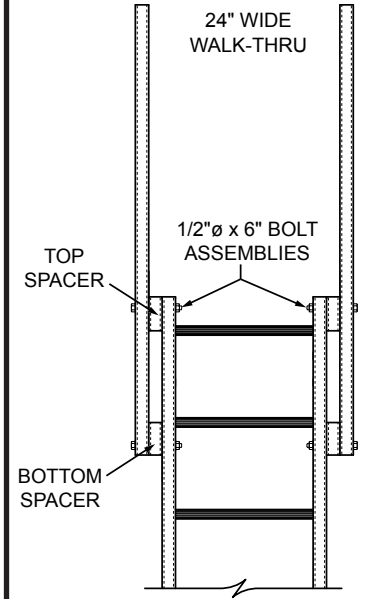

DRAWING F - STANDARD WALL MOUNT

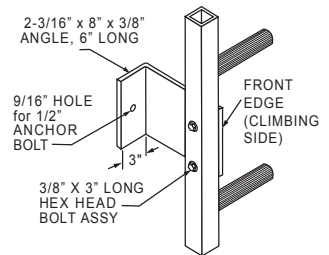

DRAWING G - BOTTOM WALL MOUNT

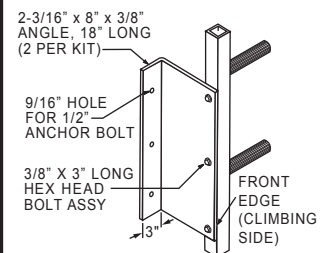

DRAWING H - FLOOR MOUNT

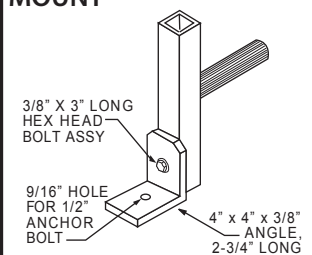

Section II - Cage Installation

DRAWING I - TOP AND BOTTOM CAGE HOOPS

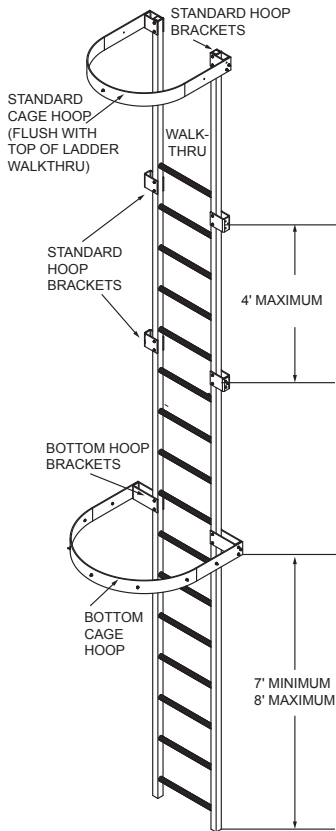

DRAWING J - VERTICAL I-BAR CONNECTION

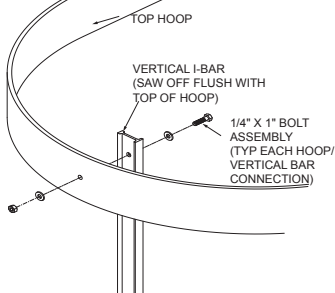

DRAWING K - VERTICAL I-BAR SPLICE

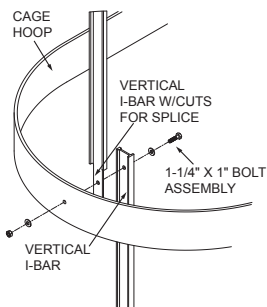

1. If your ladder has an 18" wide walk thru, locate uppermost standard cage hoop bracket flush with inside edge and top of ladder square tube rail (**Drawing I**). If your ladder has a 24" wide walk thru, eliminate the top cage hoop brackets and attach the hoops directly to the walk thru rails using 1/4" x 2-1/2" round head bolts. Proceed as for 18" wide walk thru with remaining installation.
2. Using standard cage hoop brackets as templates, drill 5/16" diameter mounting holes through the ladder rail. Bolt top hoop brackets to the ladder using the 1/4" x 3" round head bolt assemblies provided.
3. Locate bottom hoop brackets by measuring from outside of top bracket to outside of bottom cage bracket for cage height (**Drawing I**). Bottom hoop bracket should be 7' minimum, 8' maximum from walking surface at bottom of ladder. **Remember, hoops should be maximum 4' apart (see step 5).**
4. Using bottom hoop brackets as templates, drill and bolt intermediate hoop brackets to ladder using the 1/4" x 3" round head bolt assemblies provided.
5. After all brackets are attached, mount the cage hoops to the brackets using the 1/4" x 1-1/4" bolt assemblies provided (**Drawing I**).
6. Install the vertical I-bars beginning at the bottom hoop by centering vertical bar over the hole in the hoop, match drilling a 5/16" diameter hole, and bolting with the 1/4" x 1" long bolt with two flat washers and hex nut (**Drawing J**). Continue with the remaining hoops (**Drawing L**). (If vertical bars are not long enough, splice per **Drawing K**). Saw the bar flush with the top hoop.
7. Repeat step #6 until all seven vertical bars are installed.
8. Continue with steps #3 through #9 to finish your Dynarail FRP ladder system installation (**Drawing M**).

DRAWING L - VERTICAL BAR INSTALLED

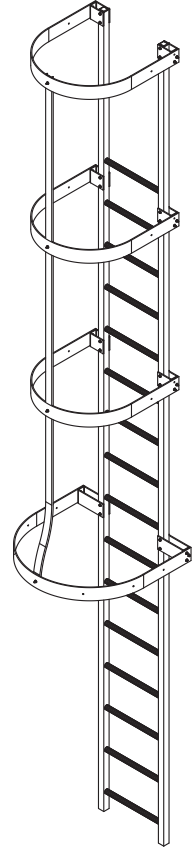

DRAWING M - INSTALLED LADDER WITH CAGE

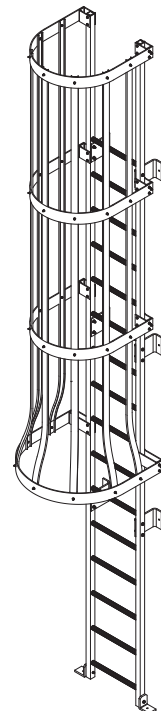

Section III - Technical Information

OSHA REQUIREMENTS FOR LADDERS & LADDER SYSTEMS

From the Code of Federal Regulations, Title 29, Labor, 1910.27

Installer is responsible for referring to most current OSHA Code for complete information.

1. (a)(1)(i) 200 lb concentrated load (minimum at center of rung)
2. (b)(1)(ii&iii) Distance between rungs maximum 12", minimum clear width between side rails of 16"
3. (c)(4) Distance from the center line of rungs to wall in back of ladder shall be not less than 7"
4. (d)(1)(ii) Cage required on ladders of more than 20' to a maximum unbroken length of 30'
5. (d)(1)(iii) Cage to extend minimum of 42" above top of landing
6. (d)(1)(iv) Cage shall begin minimum 7' to maximum 8' above base of ladder (floor)
7. (d)(1)(v) Cage shall not be less than 27" in width
8. (d)(1)(v) Cage hoop vertical bars shall be located at a maximum spacing of 40° around the circumference of the cage

TECHNICAL DATA

(All materials are yellow vinyl ester, fire retardant - VEFR)

LADDER:

Maximum length without splice	24'-0"	Outside Diameter of rung	1-1/4"
Maximum ladder length with cage	33'-6"	Inside Diameter of rung	7/8"
Clear inside width (inside rail to rail)	18"	Rail - outside width	1-3/4"
Outside width (outside rail to rail)	21-1/2"	Rail - wall thickness	1/4"
Rung Spacing (center to center)	12"	Weight per foot (approximately)	2.7 lbs.

CAGE:

Product	Description
Standard Hoop Kit (PN 448200)	27" from center line of ladder rung to inside of hoop 3" wide x 1/4" thick hand layup Predrilled holes <i>(with necessary bolt assemblies)</i>
Bottom Hoop Kit (PN 448000)	31" from center line of ladder rung to inside of hoop 3" wide x 1/4" thick hand layup Predrilled holes <i>(with necessary bolt assemblies)</i>
Hoop Brackets (Included with hoop kits)	1/4" thick, "U" shaped hand layup Predrilled holes <i>(with necessary bolt assemblies)</i>
Vertical I-Bars (PN 446211 - 10 ft; PN 446210 - 20 ft)	I-Bar, 1-1/2" deep x 5/8" flange x 1/8" thick
Bottom Wall Mount Bracket Kit* (PN 448400 ISOFR Dk Gray, PN 448401 VEFR Beige) <i>Required when ladder cannot be floor mounted</i>	2-3/16" x 8" x 3/8" angle, 18" long Two per set <i>(with necessary bolt assemblies)</i>
Wall Mount Bracket Kit* (PN 448500 ISOFR Dk Gray, PN 448501 VEFR Beige)	2-3/16" x 8" x 3/8" angle, 6" long 7" from wall to center of rung Two per set <i>(with necessary bolt assemblies)</i>
Floor Mount Clip Kit* (PN 448700 ISOFR Dk Gray, PN 448701 VEFR Beige)	4" x 4" x 3/8" angle, 2-3/4" long Two per set <i>(with necessary bolt assemblies)</i>

Fibergrate Products & Services

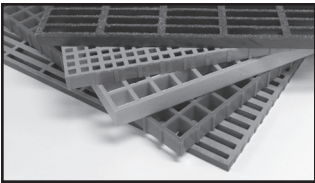

Fibergrate® Molded Grating

Fibergrate molded gratings are designed to provide the ultimate in reliable performance, even in the most demanding conditions. Fibergrate offers the widest selection in the market with multiple resins and more than twenty grating configurations available in many panel sizes and surfaces.



Safe-T-Span® Pultruded Industrial and Pedestrian Gratings

Combining corrosion resistance, long-life and low maintenance, Safe-T-Span® provides unidirectional strength for industrial and pedestrian pultruded grating applications.

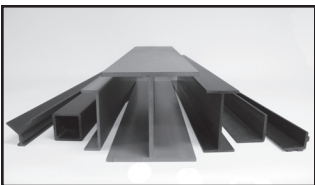

Dynaform® Structural Shapes

Fibergrate offers a wide range of standard Dynaform® pultruded structural profiles for industrial and commercial use, including I-beams, wide flange beams, round and square tubes, bars, rods, channels, leg angles and plate.



Dynarail® Guardrail, Handrail & Ladder Systems

Easily assembled from durable components or engineered and prefabricated to your specifications, Dynarail® guardrail, handrail and safety ladder systems meet or exceed OSHA and strict building code requirements for safety and design.

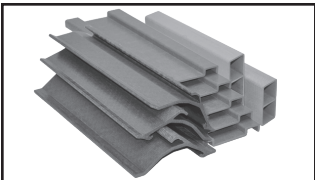

Custom Composite Solutions

Combining Fibergrate's design, manufacturing and fabrication services allows Fibergrate to offer custom composite solutions to meet our client's specific requirements. Either through unique pultruded profiles or custom open molding, Fibergrate can help bring your vision to reality.



Design & Fabrication Services

Combining engineering expertise with an understanding of fiberglass applications, Fibergrate provides turnkey design and fabrication of fiberglass structures, including platforms, catwalks, stairways, railings and equipment support structures.



Worldwide Sales & Distribution Network

Whether a customer requires a platform in a mine in South Africa to grating on an oil rig in the North Sea, or walkways in a Wisconsin cheese plant to handrails at a water treatment facility in Brazil; Fibergrate has sales and service locations throughout the world to meet the needs and exceed the expectations of any customer.

Fibergrate Composite Structures Inc. believes the information contained here to be true and accurate. Fibergrate makes no warranty, expressed or implied, based on this literature and assumes no responsibility for the consequential or incidental damages in the use of these products and systems described, including any warranty of merchantability or fitness. Information contained here can be for evaluation only. The marks and trade names appearing herein, whether registered or unregistered, are the property of Fibergrate Composite Structures Inc.

©Fibergrate Inc. 2014 Part No. 883302-10/14-0.5
Printed in the USA

